

Advanced Performance and Wide Range of Selections in a Super-compact Size

- Only 5.5 × 5.5 mm with a built-in Amplifier.
- Maximum sensing distance: 2.5 mm. Stable detection even with workpiece fluctuations.
- Response frequency: 1 kHz.
- Low current consumption.



 Be sure to read *Safety Precautions* on page 6.



Ordering Information

Sensors [Refer to *Dimensions* on page 7.]
DC 2-Wire Models

Appearance	Sensing surface	Sensing distance	Model	
			Operation mode	
			NO	NC
Unshielded 	Top	1.6 mm	E2S-W11 1M *	E2S-W12 1M
	Front		E2S-Q11 1M *	E2S-Q12 1M
	Top	2.5 mm	E2S-W21 1M *	E2S-W22 1M
	Front		E2S-Q21 1M *	E2S-Q22 1M

* Models with a different frequency are also available to prevent mutual interference. The model numbers are E2S-□□□B (e.g., E2S-W11B).





DC 3-Wire Models

Appearance	Sensing surface	Sensing distance	Output configuration	Model	
				Operation mode	
				NO	NC
Unshielded 	Top	1.6 mm	NPN	E2S-W13 1M *	E2S-W14 1M
	Front			E2S-Q13 1M *	E2S-Q14 1M
	Top	2.5 mm		E2S-W23 1M *	E2S-W24 1M
	Front			E2S-Q23 1M *	E2S-Q24 1M
	Top	1.6 mm	PNP	E2S-W15 1M *	E2S-W16 1M
	Front			E2S-Q15 1M *	E2S-Q16 1M
	Top	2.5 mm		E2S-W25 1M *	E2S-W26 1M
	Front			E2S-Q25 1M *	E2S-Q26 1M

* Models with a different frequency are also available to prevent mutual interference. The model numbers are E2S-LLLLIB (e.g., E2S-W13B).

Accessories (Order Separately)

Mounting Brackets [Refer to *Dimensions* on page 7.]

Appearance	Model	Quantity	Remarks
	Y92E-C1R6	1	Provided with E2S-□1□□. (fixed with one screw)
	Y92E-C2R5		Provided with E2S-□2□□. (fixed with one screw)
	Y92E-D1R6		For E2S-□1□□ (fixed with two screws)
	Y92E-D2R5		For E2S-□2□□ (fixed with two screws)

Model Number Legend

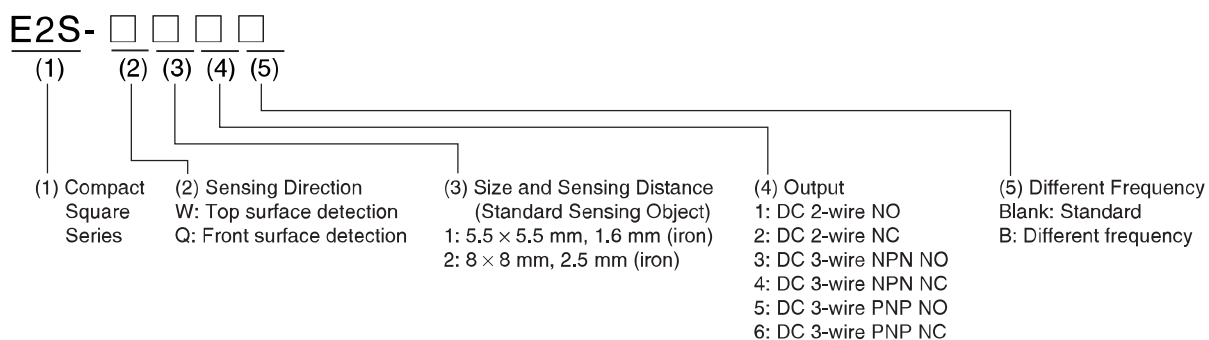

Ratings and Specifications

DC 2-Wire Models

Item	Model	E2S-W11 E2S-W12	E2S-Q11 E2S-Q12	E2S-W21 E2S-W22	E2S-Q21 E2S-Q22
Sensing surface		Top	Front	Top	Front
Sensing distance		1.6 mm ±15%		2.5 mm ±15%	
Set distance		0 to 1.2 mm		0 to 1.9 mm	
Differential travel		10% max. of sensing distance			
Detectable object		Ferrous metal (The sensing distance decreases with non-ferrous metal. Refer to <i>Engineering Data</i> on page 4.)			
Standard sensing object		Iron, 12 × 12 × 1 mm		Iron, 15 × 15 × 1 mm	
Response frequency *		1 kHz min.			
Power supply voltage (operating voltage range)		12 to 24 VDC (10 to 30 VDC), ripple (p-p): 10% max.			
Leakage current		0.8 mA max.			
Control output	Load current	3 to 50 mA max.			
	Residual voltage	3 V max. (under load current of 50 mA with cable length of 1 m)			
Indicators		<input type="checkbox"/> 1 Models: Operation indicator (red), Setting indicator (green) <input type="checkbox"/> 2 Models: Operation indicator (red)			
Operation mode (with sensing object approaching)		<input type="checkbox"/> 1 Models: NO <input type="checkbox"/> 2 Models: NC Refer to the timing charts under <i>I/O Circuit Diagrams</i> on page 5 for details.			

* The response frequency is an average value.

Measurement conditions are as follows: standard sensing object, a distance of twice the standard sensing object, and a set distance of half the sensing distance.

DC 3-Wire Models

Item	Model	E2S-W13 E2S-W14	E2S-Q13 E2S-Q14	E2S-W23 E2S-W24	E2S-Q23 E2S-Q24	E2S-W15 E2S-W16	E2S-Q15 E2S-Q16	E2S-W25 E2S-W26	E2S-Q25 E2S-Q26
Sensing surface		Top	Front	Top	Front	Top	Front	Top	Front
Sensing distance		1.6 mm ±15%		2.5 mm ±15%		1.6 mm ±15%		2.5 mm ±15%	
Set distance		0 to 1.2 mm		0 to 1.9 mm		0 to 1.2 mm		0 to 1.9 mm	
Differential travel		10% max. of sensing distance							
Detectable object		Ferrous metal (The sensing distance decreases with non-ferrous metal. Refer to <i>Engineering Data</i> on page 4.)							
Standard sensing object		Iron, 12 × 12 × 1 mm		Iron, 15 × 15 × 1 mm		Iron, 12 × 12 × 1 mm		Iron, 15 × 15 × 1 mm	
Response frequency *		1 kHz min.							
Power supply voltage (operating voltage range)		12 to 24 VDC (10 to 30 VDC), ripple (p-p): 10% max.							
Current consumption		13 mA max. at 24 VDC (no-load)							
Control output	Load current	NPN open-collector output, 50 mA max. (30 VDC max.)				PNP open-collector output, 50 mA max. (30 VDC max.)			
	Residual voltage	1.0 V max. (under load current of 50 mA with cable length of 1 m)							
Indicators		Operation indicator (orange)							
Operation mode (with sensing object approaching)		<input type="checkbox"/> 3 Models: NO <input type="checkbox"/> 4 Models: NC Refer to the timing charts under <i>I/O Circuit Diagrams</i> on page 5 for details.				<input type="checkbox"/> 5 Models: NO <input type="checkbox"/> 6 Models: NC Refer to the timing charts under <i>I/O Circuit Diagrams</i> on page 5 for details.			

* The response frequency is an average value.

Measurement conditions are as follows: standard sensing object, a distance of twice the standard sensing object, and a set distance of half the sensing distance.

Specifications

Item	Model	E2S-□□□
Protection circuits	Reverse polarity protection, Surge suppressor	
Ambient temperature range	Operating: -25 to 70°C (with no icing or condensation), Storage: -40 to 85°C (with no icing or condensation)	
Ambient humidity range	Operating: 35% to 90% (with no condensation), Storage: 35% to 95% (with no condensation)	
Temperature influence	±15% max. of sensing distance at 23°C in the temperature range of -25 to 70°C	
Voltage influence	±2.5% max. of sensing distance at rated voltage in rated voltage ±10% range	
Insulation resistance	50 MΩ min. (at 500 VDC) between current-carrying parts and case	
Dielectric strength	1,000 VAC for 1 min between current-carrying parts and case	
Vibration resistance	Destruction: 10 to 55 Hz, 1.5-mm double amplitude for 2 hours each in X, Y, and Z directions	
Shock resistance	Destruction: 500 m/s ² 3 times each in X, Y, and Z directions	
Degree of protection	IEC 60529 IP67	
Connection method	Pre-wired Models (Standard cable length: 1 m)	
Weight (packed state)	Approx. 10 g	
Materials	Case	Polyarylate resin
Accessories	Mounting Brackets	

Engineering Data (Typical)

Sensing Area

E2S-W1□/-W2□

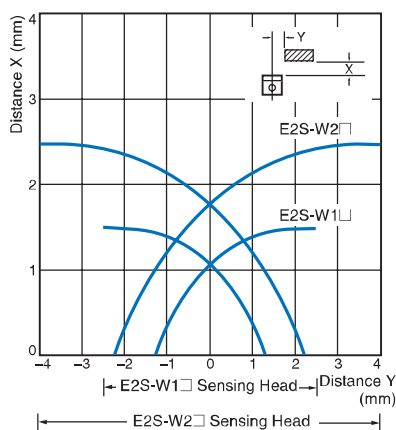

E2S-Q1□/-Q2□

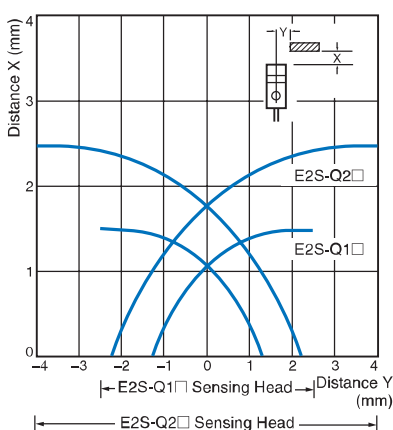

Influence of Sensing Object Size and Material

E2S-W1□/-Q1□

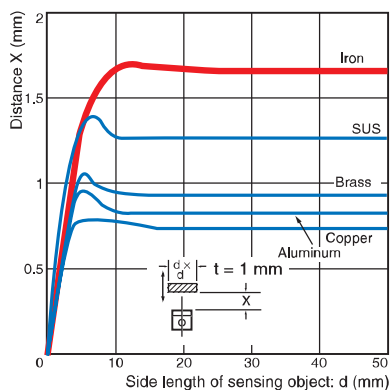

E2S-W2□/-Q2□

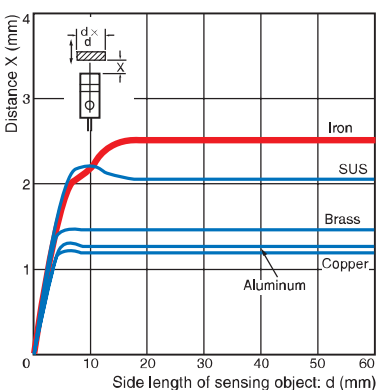

I/O Circuit Diagrams

DC 2-Wire Models

Operation mode	Model	Timing chart	Output circuit
NO	E2S-W11 E2S-W21 E2S-Q11 E2S-Q21		
NC	E2S-W12 E2S-W22 E2S-Q12 E2S-Q22		

Note: The load can be connected to either the +V or 0V side.

DC 3-Wire Models

Operation mode	Output configuration	Model	Timing chart	Output circuit
NO	NPN	E2S-W13 E2S-W23 E2S-Q13 E2S-Q23		
NC		E2S-W14 E2S-W24 E2S-Q14 E2S-Q24		
NO	PNP	E2S-W15 E2S-W25 E2S-Q15 E2S-Q25		
NC		E2S-W16 E2S-W26 E2S-Q16 E2S-Q26		

* Load current: 50 mA max.

* Load current: 50 mA max.

Safety Precautions

Refer to *Warranty and Limitations of Liability*.

⚠ WARNING

This product is not designed or rated for ensuring safety of persons either directly or indirectly. Do not use it for such purposes.



Precautions for Correct Use

Do not use this product under ambient conditions that exceed the ratings.

● **Design**

Influence of Surrounding Metal

• When mounting the Sensor within a metal panel, ensure that the clearances given in the following table are maintained. Failure to maintain these distances may cause deterioration in the performance of the Sensor.

• Models with Top Sensing Surface

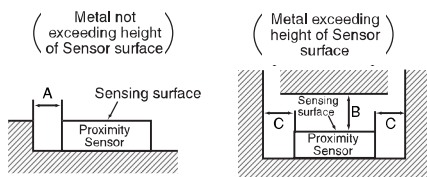

(Unit: mm)

Model	Distance	A	B	C
E2S-W1□	0	0	8	2
E2S-W2□			15	10

• Models with Front Sensing Surface

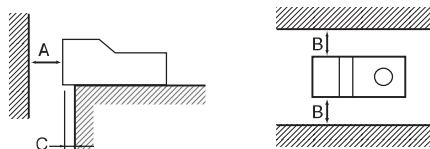

(Unit: mm)

Model	Distance	A	B	C
E2S-Q1□	8	3	2	
E2S-Q2□	15	10	3	

Applicable e-CON Connector Models and Manufacturers

The companies and model number of e-CON connections that can be used with Sensor cables are listed in the following table. Confirm applicability when purchasing e-CON connectors for connection to Pre-wired Sensors.

Model	Tyco Electronics AMP K.K.
E2S-W□3/4	1-1473562-4 (red)
E2S-Q□3/4	

Mutual Interference

When installing Sensors face-to-face or side-by-side, ensure that the minimum distances given in the following table are maintained.

• Models with Top Sensing Surface

• Models with Front Sensing Surface

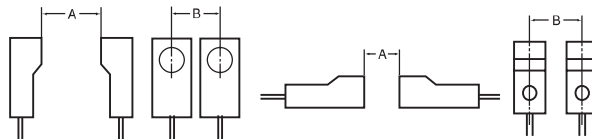

(Unit: mm)

Model	Distance	A	B
E2S-W(Q)1□	50 (40)	20 (5.5)	
E2S-W(Q)2□	75 (50)	25 (8)	

Note: Values in parentheses apply to Sensors operating at different frequencies.

● **Mounting**

Tightening Torque

For the E2S-W(Q)2□, the maximum tightening torque that should be applied to the mounting screws is 0.7 N·m.

Dimensions

(Unit: mm)
Tolerance class IT16 applies to dimensions in this data sheet unless otherwise specified.

Sensors

E2S-W1 □

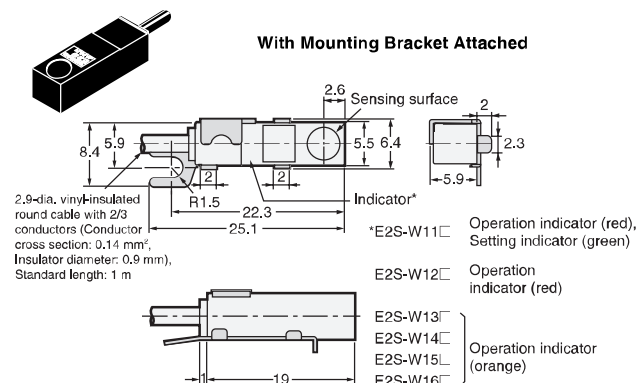

E2S-Q1 □

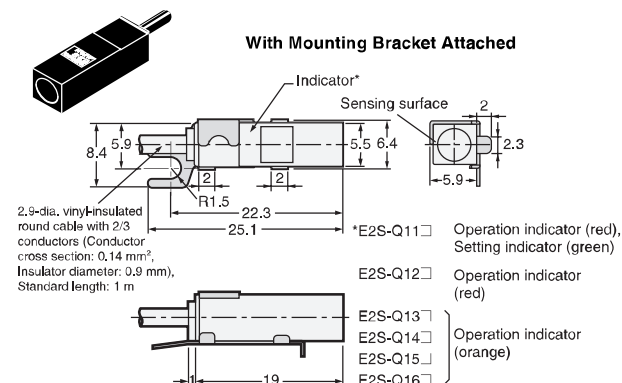

E2S-W2 □

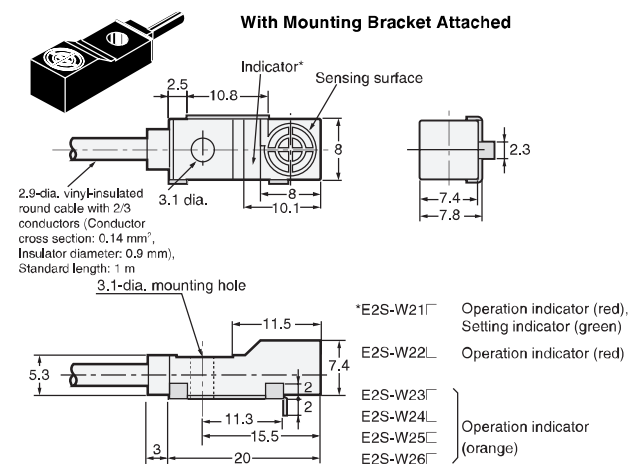

E2S-Q2 □

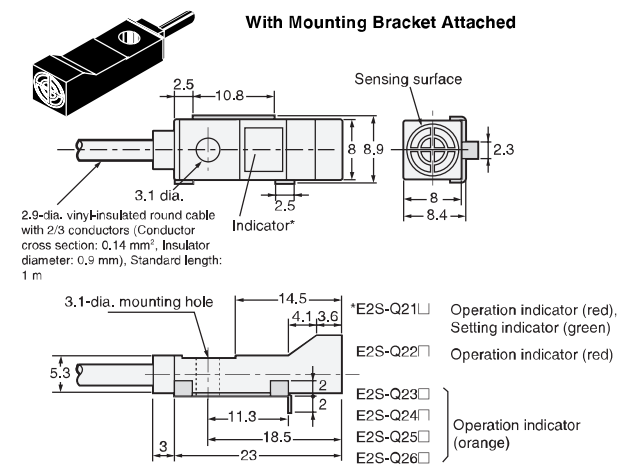

Accessories (Order Separately)

Mounting Bracket
Y92E-C1R6

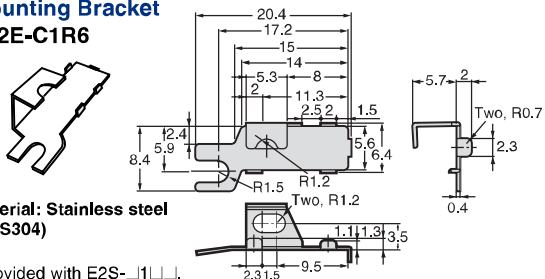

Material: Stainless steel (SUS304)

* Provided with E2S-J1□□□.

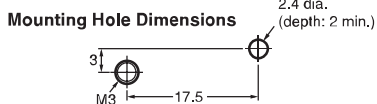

Mounting Bracket
Y92E-C2R5

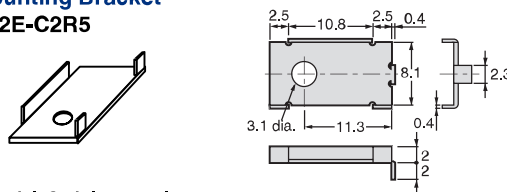

Material: Stainless steel (SUS304)

* Provided with E2S-L2□□□.

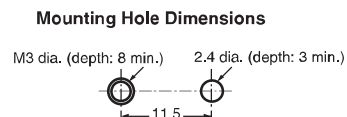

Mounting Bracket
Y92E-D1R6

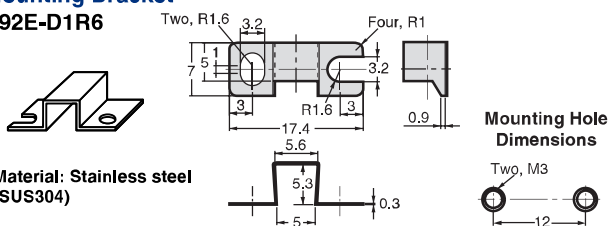

Material: Stainless steel (SUS304)

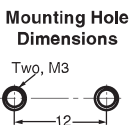

Mounting Bracket
Y92E-D2R5

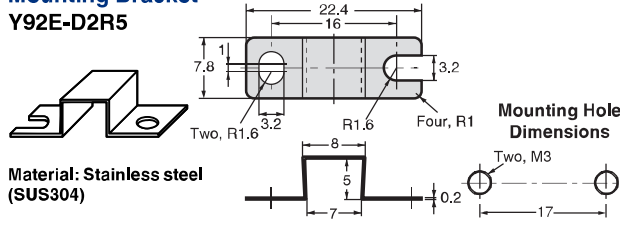

Material: Stainless steel (SUS304)

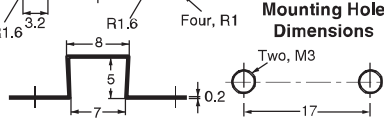

Read and Understand This Catalog

Please read and understand this catalog before purchasing the products. Please consult your OMRON representative if you have any questions or comments.

Warranty and Limitations of Liability

WARRANTY

OMRON's exclusive warranty is that the products are free from defects in materials and workmanship for a period of one year (or other period if specified) from date of sale by OMRON.

OMRON MAKES NO WARRANTY OR REPRESENTATION, EXPRESS OR IMPLIED, REGARDING NON-INFRINGEMENT, MERCHANTABILITY, OR FITNESS FOR PARTICULAR PURPOSE OF THE PRODUCTS. ANY BUYER OR USER ACKNOWLEDGES THAT THE BUYER OR USER ALONE HAS DETERMINED THAT THE PRODUCTS WILL SUITABLY MEET THE REQUIREMENTS OF THEIR INTENDED USE. OMRON DISCLAIMS ALL OTHER WARRANTIES, EXPRESS OR IMPLIED.

LIMITATIONS OF LIABILITY

OMRON SHALL NOT BE RESPONSIBLE FOR SPECIAL, INDIRECT, OR CONSEQUENTIAL DAMAGES, LOSS OF PROFITS OR COMMERCIAL LOSS IN ANY WAY CONNECTED WITH THE PRODUCTS, WHETHER SUCH CLAIM IS BASED ON CONTRACT, WARRANTY, NEGLIGENCE, OR STRICT LIABILITY.

In no event shall the responsibility of OMRON for any act exceed the individual price of the product on which liability is asserted.

IN NO EVENT SHALL OMRON BE RESPONSIBLE FOR WARRANTY, REPAIR, OR OTHER CLAIMS REGARDING THE PRODUCTS UNLESS OMRON'S ANALYSIS CONFIRMS THAT THE PRODUCTS WERE PROPERLY HANDLED, STORED, INSTALLED, AND MAINTAINED AND NOT SUBJECT TO CONTAMINATION, ABUSE, MISUSE, OR INAPPROPRIATE MODIFICATION OR REPAIR.

Application Considerations

SUITABILITY FOR USE

OMRON shall not be responsible for conformity with any standards, codes, or regulations that apply to the combination of products in the customer's application or use of the products.

At the customer's request, OMRON will provide applicable third party certification documents identifying ratings and limitations of use that apply to the products. This information by itself is not sufficient for a complete determination of the suitability of the products in combination with the end product, machine, system, or other application or use.

The following are some examples of applications for which particular attention must be given. This is not intended to be an exhaustive list of all possible uses of the products, nor is it intended to imply that the uses listed may be suitable for the products:

- Outdoor use, uses involving potential chemical contamination or electrical interference, or conditions or uses not described in this catalog.
- Nuclear energy control systems, combustion systems, railroad systems, aviation systems, medical equipment, amusement machines, vehicles, safety equipment, and installations subject to separate industry or government regulations.
- Systems, machines, and equipment that could present a risk to life or property.

Please know and observe all prohibitions of use applicable to the products.

NEVER USE THE PRODUCTS FOR AN APPLICATION INVOLVING SERIOUS RISK TO LIFE OR PROPERTY WITHOUT ENSURING THAT THE SYSTEM AS A WHOLE HAS BEEN DESIGNED TO ADDRESS THE RISKS, AND THAT THE OMRON PRODUCTS ARE PROPERLY RATED AND INSTALLED FOR THE INTENDED USE WITHIN THE OVERALL EQUIPMENT OR SYSTEM.

PROGRAMMABLE PRODUCTS

OMRON shall not be responsible for the user's programming of a programmable product, or any consequence thereof.

Disclaimers

CHANGE IN SPECIFICATIONS

Product specifications and accessories may be changed at any time based on improvements and other reasons.

It is our practice to change model numbers when published ratings or features are changed, or when significant construction changes are made. However, some specifications of the products may be changed without any notice. When in doubt, special model numbers may be assigned to fix or establish key specifications for your application on your request. Please consult with your OMRON representative at any time to confirm actual specifications of purchased products.

DIMENSIONS AND WEIGHTS

Dimensions and weights are nominal and are not to be used for manufacturing purposes, even when tolerances are shown.

PERFORMANCE DATA

Performance data given in this catalog is provided as a guide for the user in determining suitability and does not constitute a warranty. It may represent the result of OMRON's test conditions, and the users must correlate it to actual application requirements. Actual performance is subject to the OMRON Warranty and Limitations of Liability.

ERRORS AND OMISSIONS

The information in this document has been carefully checked and is believed to be accurate; however, no responsibility is assumed for clerical, typographical, or proofreading errors, or omissions.

2008.11

In the interest of product improvement, specifications are subject to change without notice.

OMRON Corporation
Industrial Automation Company

<http://www.ia.omron.com/>

(c)Copyright OMRON Corporation 2008 All Right Reserved.